



Lighting Best International Ltd.

Product specification

Model No.:LB-IS160A

Product name:

50W-120W LED high bay light

1. Main picture



2. product dimension

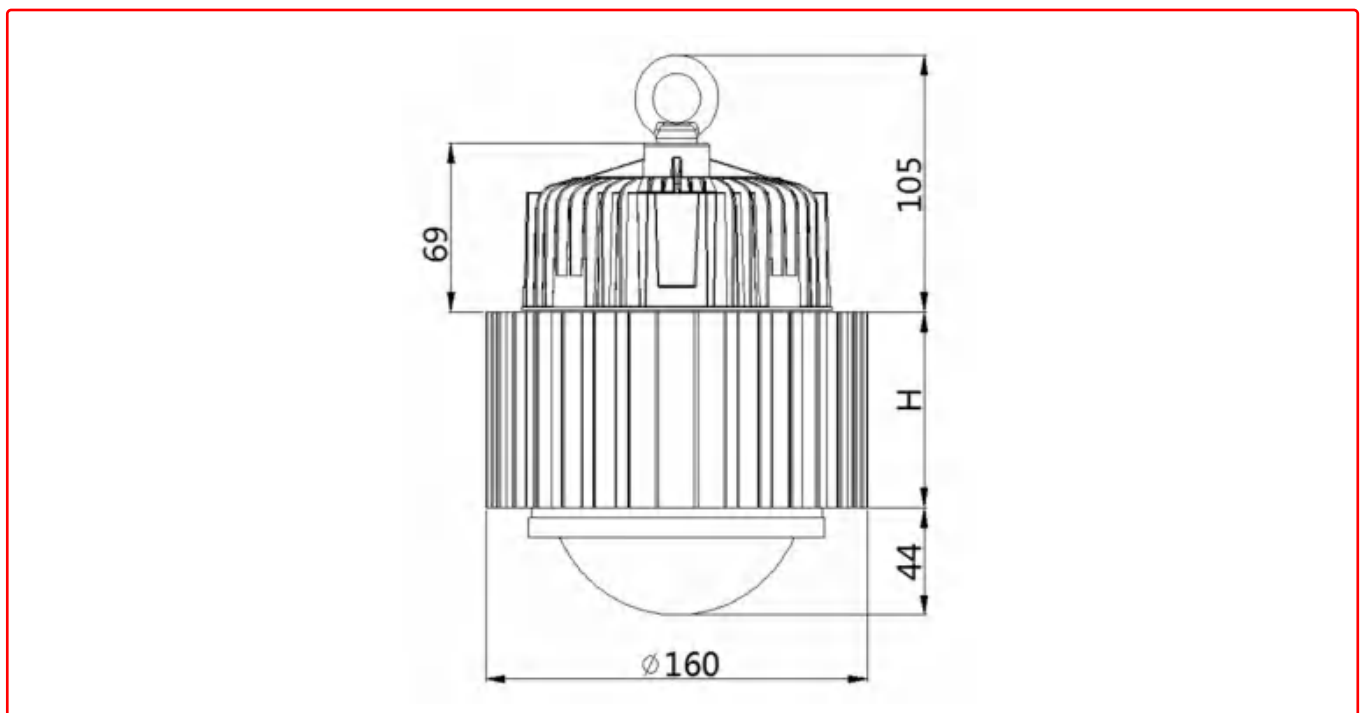

3.product feature

- 1.high quality extruded aluminum sun-flower pattern heatsink, good heat transfer and heat dissipation effect, the product light decay is minimal;
2. Flip-chip light source, vertical heat dissipation structure, light source failure rate is almost 0%, long life, low decay;
- 3.lots of reflector and beam angle options;
4. beam angle 25 °/45 °/60 °/90 °/120 °optional.
5. Ip65.
- 6.UL listed.



4.Quick Details

Keyword:	LED high bay light	Model Number:	LB-IS160-WAAA
lighting power range	50 ~ 120W	main material of Housing	extruded 6063 aluminum heatsink, ADC12 Die-cast driver box
support customize	yes	optical structure design	Aluminum reflector + PC lens
Input Voltage(V):	AC100 ~ 240V/50/60HZ	power factor	> 0.95
Driver Brand:	lightingbest/others	Extra function optional /Smart Functions:	TBD
Place of Origin:	China	product Brand:	lightingbest or customize
LED Chip Brand:	cree/bridgelux/citizen/SanAn/others	Luminous Efficiency(lm/w):	max160LM/W(when CCT6000K)
LED type	flip-chip COB	Beam angle:	/25° /45° /60° /90° /120°
Color Temperature(CCT):	3000k-6500k optional	CRI (Ra>):	70 ~ 90 optional
working time(Hours)	30 minutes to 8 hours optional	Warranty(except lithium battery):	5 Years
certificate	CE、Rohs、UL、SAA	IP Rating:	IP65 Waterproof
Working Temperature(°C):	35 ~ 60	storage temperature	-30°C ~ +50°C
packing size(mm)	250*250*375(for lamp) consult our sales for reflector	N.W./G.W. (kg)	4.3/4.9 (kg)(for lamp) consult our sales for reflector

5.1 partial optical parameter and lights distributor curve

LUMINOUS INTENSITY DISTRIBUTION DIAGRAM

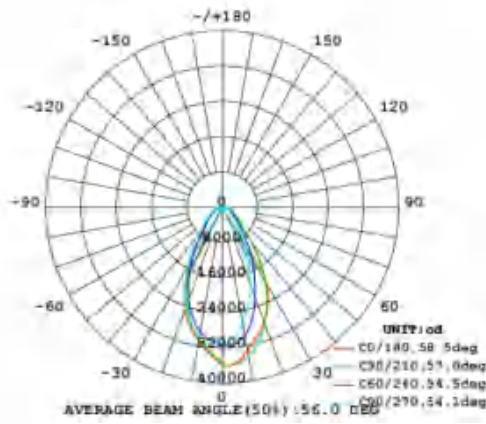

Beam angle 60°

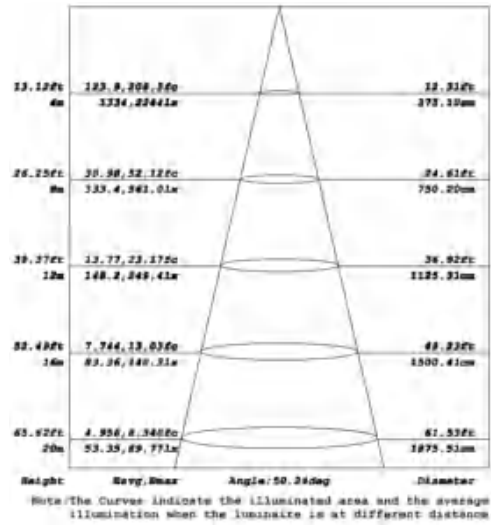

when power: 300W

LUMINOUS INTENSITY DISTRIBUTION DIAGRAM

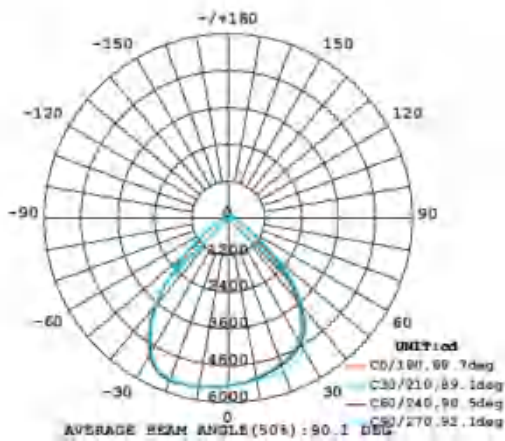

Beam angle 90°

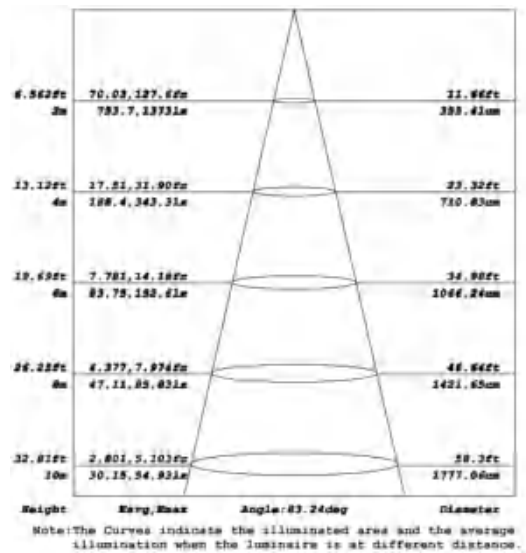

when power: 80W

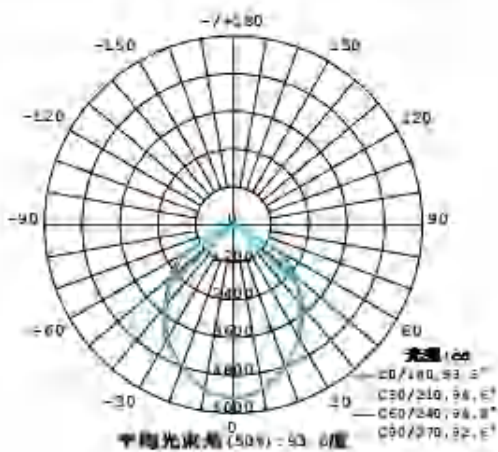

Beam angle 120°

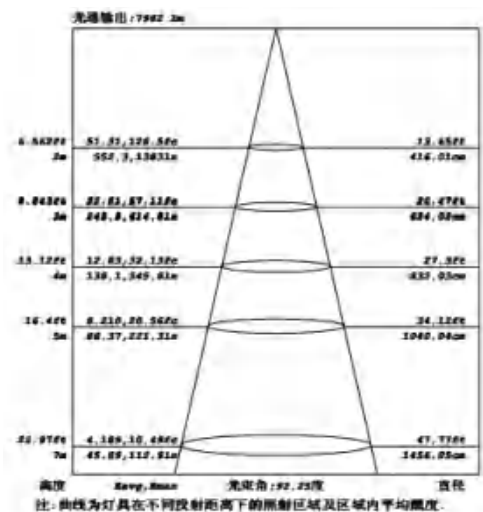

when power: 100W

5.2 UL certificate

CERTIFICATE OF COMPLIANCE

Certificate Number 20141211-E472884
Report Reference E472884-20141130
Issue Date 2014-DECEMBER-11

Issued to: Lighting Best International Ltd
Zone A F112, Bldg 22 Chuangye Industrial Zone
Shajuwai Community Songgang St Baoan
Shenzhen, 518104 CHINA

This is to certify that representative samples of LIGHT-EMITTING-DIODE SURFACE-MOUNTED LUMINAIRES
Light-emitting-diode surface-mounted luminaires,
Models LB-IM160-WCCC, LB-IS160-WAAA, LB-IS160-WBBB,
LB-IS160-WCCC, LB-IS200-WAAA, LB-IS250-WAAA, LB-
IS320-WAAA, LB-TD450-WAAA, LB-FS200-WAAA, LB-ID320-
WBBB.

Have been investigated by UL in accordance with the Standard(s) indicated on this Certificate.

Standard(s) for Safety: UL 1598 AND CSA C22.2 No. 250.0-08, Luminaires,
UL 8750, Standard For Light Emitting Diode (LED) Equipment
For Use In Lighting Products

Additional Information: See the UL Online Certifications Directory at
www.ul.com/database for additional information

Only those products bearing the UL Certification Mark should be considered as being covered by UL's Certification and Follow-Up Service.

Look for the UL Certification Mark on the product.

This is to certify that representative samples of the product as specified on this certificate were tested according to the current UL requirements.



Bruce Robinson, Assistant Chief Engineer, Global Inspection and Field Service

UL LLC

Any information and documentation involving UL listed services are provided on behalf of UL LLC (UL) or any authorized licensee of UL. For questions, please contact a local UL Customer Service Representative at www.ul.com/contact.



5.3 CE, Rohs & Ip65 certifficate

TCD

Certificate of Compliance

REPORT NO: TCD2015032310308E-1
 CERTIFICATE NO: TCD2015032310308E-1

Applicant: Lighting Best International Limited
Address: F12, bldg 22(Pujing Semiconductor Ind.Park),Chuangye Ind. Zone, Shapawei Community, Songgang St, Baoan, Shenzhen

Manufacturer: Lighting Best International Limited
Address: F12, bldg 22(Pujing Semiconductor Ind.Park),Chuangye Ind. Zone, Shapawei Community, Songgang St, Baoan, Shenzhen

Product: LED High Bay Light

Model: LB-45160-W030, LB-45160-W050, LB-45160-W060, LB-45160-W100, LB-4M160-W100, LB-DS160-W060, LB-DS160-W100, LB-DM160-W100, LB-DM160-W120, LB-4Q230-W120, LB-4Q230-W200, LB-4S200-W100, LB-4S200-W120, LB-4S200-W180, LB-4S300-W180, LB-4M200-W180, LB-DS200-W120, LB-DS200-W180, LB-DM200-W150, LB-DM200-W180, LB-4S240-W200, LB-4S240-W240, LB-4M250-W200, LB-4M250-W240, LB-4M250-W300, LB-4M250-W320, LB-DM250-W200, LB-DM250-W240, LB-DM250-W300, LB-4S320-W300, LB-4S320-W400, LB-4D320-W400, LB-4D320-W500, LB-4D320-W600, LB-4D320-W800, LB-4D320-W1000, LB-4D320-W1200, LB-DM320-W800, LB-DM320-W1000, LB-DM320-W1200, LB-DM500-W1200

Rated: LB-4S200-W100, 100W, AC 100-240V, 50/60Hz

Test Standard: EN 55015:2012
 EN 61547:2008
 EN 61000-3-2:2006+A1:2009+A2:2009
 EN 61000-3-3:2013

The EUT described above has been tested by us with the listed standards and found in compliance with the council EMC directive 2014/53/EU. It is possible to use CE marking to demonstrate the compliance with this EMC Directive.

The certificate applies to the tested sample above mentioned only and shall not imply an assessment of the whole production. It is only valid in connection with the test report number: TCD2015032310308E-1



 Chief Engineer
 Date of Issue: Mar 23, 2015
 Lovia Li

Shenzhen TCD Testing Technology Co., LTD.
 Tel: 0755-2976 0321 Fax: 0755-2976 1725
 #1 Lianhang Building, Guohu 1 Road, Xixiang Street, Baoan District, Shenzhen, Guangdong, China

TCD

Certificate of Compliance

REPORT NO: TCD2015032310308E-1
 CERTIFICATE NO: TCD2015032310308E-1

Applicant: Lighting Best International Limited
Address: F12, bldg 22(Pujing Semiconductor Ind.Park),Chuangye Ind. Zone, Shapawei Community, Songgang St, Baoan, Shenzhen

Manufacturer: Lighting Best International Limited
Address: F12, bldg 22(Pujing Semiconductor Ind.Park),Chuangye Ind. Zone, Shapawei Community, Songgang St, Baoan, Shenzhen

Product: LED High Bay Light

Model: LB-45160-W030, LB-45160-W050, LB-45160-W060, LB-45160-W100, LB-4M160-W100, LB-DS160-W060, LB-DS160-W100, LB-DM160-W100, LB-DM160-W120, LB-4Q230-W120, LB-4Q230-W200, LB-4S200-W100, LB-4S200-W120, LB-4S200-W180, LB-4S300-W180, LB-4M200-W180, LB-DS200-W120, LB-DS200-W180, LB-DM200-W150, LB-DM200-W180, LB-4S240-W200, LB-4S240-W240, LB-4M250-W200, LB-4M250-W240, LB-4M250-W300, LB-4M250-W320, LB-DM250-W200, LB-DM250-W240, LB-DM250-W300, LB-4S320-W300, LB-4S320-W400, LB-4D320-W400, LB-4D320-W500, LB-4D320-W600, LB-4D320-W800, LB-4D320-W1000, LB-4D320-W1200, LB-DM320-W800, LB-DM320-W1000, LB-DM320-W1200, LB-DM500-W1200

Rated: LB-4S200-W100, 100W, AC 100-240V, 50/60Hz

Test Standard: EN 62031:2008
 EN 62485:2010
 EN 60598-1:2008+A11:2009

The EUT described above has been tested by us with the listed standards and found in compliance with the council LVD directive 2006/95/EC. It is possible to use CE marking to demonstrate the compliance with this LVD Directive.

The certificate applies to the tested sample above mentioned only and shall not imply an assessment of the whole production. It is only valid in connection with the test report number: TCD2015032310308E-1



 Chief Engineer
 Date of Issue: Mar 23, 2015
 Lovia Li

Shenzhen TCD Testing Technology Co., LTD.
 Tel: 0755-2976 0321 Fax: 0755-2976 1725
 #1 Lianhang Building, Guohu 1 Road, Xixiang Street, Baoan District, Shenzhen, Guangdong, China

TCD

Certificate of Compliance

REPORT NO: TCD2015032310308R-1
 CERTIFICATE NO: TCD2015032310308R-1

Applicant: Lighting Best International Limited
Address: F12, bldg 22(Pujing Semiconductor Ind.Park),Chuangye Ind. Zone, Shapawei Community, Songgang St, Baoan, Shenzhen

Manufacturer: Lighting Best International Limited
Address: F12, bldg 22(Pujing Semiconductor Ind.Park),Chuangye Ind. Zone, Shapawei Community, Songgang St, Baoan, Shenzhen

Product: LED High Bay Light

Model: LB-45160-W030, LB-45160-W050, LB-45160-W060, LB-45160-W100, LB-4M160-W100, LB-DS160-W060, LB-DS160-W100, LB-DM160-W100, LB-DM160-W120, LB-4Q230-W120, LB-4Q230-W200, LB-4S200-W100, LB-4S200-W120, LB-4S200-W180, LB-4S300-W180, LB-4M200-W180, LB-DS200-W120, LB-DS200-W180, LB-DM200-W150, LB-DM200-W180, LB-4S240-W200, LB-4S240-W240, LB-4M250-W200, LB-4M250-W240, LB-4M250-W300, LB-4M250-W320, LB-DM250-W200, LB-DM250-W240, LB-DM250-W300, LB-4S320-W300, LB-4S320-W400, LB-4D320-W400, LB-4D320-W500, LB-4D320-W600, LB-4D320-W800, LB-4D320-W1000, LB-4D320-W1200, LB-DM320-W800, LB-DM320-W1000, LB-DM320-W1200, LB-DM500-W1200

Rated: LB-4S200-W100, 100W, AC 100-240V, 50/60Hz

Test Standard: EPA 2860B, 1998 EN1122:2001
 EPA 2452, 1998, EPA 2066A, 1996
 EPA 7135A, 1992 EPA 3540C, 1996, EPA627D, 2007
 IEC 62321, 2008

This is to certify that, on the basis of the tests undertaken as per Report No.: TCD2015032310308R-1, the submitted sample of the above item complies with: And fulfills testing requirement of the RoHS directive 2011/65/EU



 Chief Engineer
 Date of Issue: Mar 23, 2015
 Lovia Li

Shenzhen TCD Testing Technology Co., LTD.
 Tel: 0755-2976 0321 Fax: 0755-2976 1725
 #1 Lianhang Building, Guohu 1 Road, Xixiang Street, Baoan District, Shenzhen, Guangdong, China

TCD

Certificate of Compliance

REPORT NO: TCD2015032310308SP-1
 CERTIFICATE NO: TCD2015032310308SP-1

Applicant: Lighting Best International Limited
Address: F12, bldg 22(Pujing Semiconductor Ind.Park),Chuangye Ind. Zone, Shapawei Community, Songgang St, Baoan, Shenzhen

Manufacturer: Lighting Best International Limited
Address: F12, bldg 22(Pujing Semiconductor Ind.Park),Chuangye Ind. Zone, Shapawei Community, Songgang St, Baoan, Shenzhen

Product: LED High Bay Light

Model: LB-45160-W030, LB-45160-W050, LB-45160-W060, LB-45160-W100, LB-4M160-W100, LB-DS160-W060, LB-DS160-W100, LB-DM160-W100, LB-DM160-W120, LB-4Q230-W120, LB-4Q230-W200, LB-4S200-W100, LB-4S200-W120, LB-4S200-W180, LB-4S300-W180, LB-4M200-W180, LB-DS200-W120, LB-DS200-W180, LB-DM200-W150, LB-DM200-W180, LB-4S240-W200, LB-4S240-W240, LB-4M250-W200, LB-4M250-W240, LB-4M250-W300, LB-4M250-W320, LB-DM250-W200, LB-DM250-W240, LB-DM250-W300, LB-4S320-W300, LB-4S320-W400, LB-4D320-W400, LB-4D320-W500, LB-4D320-W600, LB-4D320-W800, LB-4D320-W1000, LB-4D320-W1200, LB-DM320-W800, LB-DM320-W1000, LB-DM320-W1200, LB-DM500-W1200

Rated: LB-4S200-W100, 100W, AC 100-240V, 50/60Hz

Test Standard: EN 60529:1991/A1:2000

The EUT described above has been tested by us with the listed standards and found in compliance with the council LVD directive 2006/95/EC

The certificate applies to the tested sample above mentioned only and shall not imply an assessment of the whole production. It is only valid in connection with the test report number: TCD2015032310308SP-1



 Chief Engineer
 Date of Issue: Mar 23, 2015
 Lovia Li

Shenzhen TCD Testing Technology Co., LTD.
 Tel: 0755-2976 0321 Fax: 0755-2976 1725
 #1 Lianhang Building, Guohu 1 Road, Xixiang Street, Baoan District, Shenzhen, Guangdong, China

6. Application scene

General:Factory, Warehouse,Workshop,Square,Parking Lot, Supermarket,advertising lighting, Garden, Public place, Exhibition hall, stadium etc.



7. Contact us

mobile/wechat/whatsapp/skype(same number)

+86 13316916698